

BBG7650SA

7000 Series Classic 5 Burner Built in BBQ

For built-in installations: islands, masonry, other non-combustible material structures.

To suit models: BBG7650SA	5 burner
Width	973mm
Height (lid closed)	555mm
Depth (includes 20mm rear ventilation clearance)	640mm
Clearance at rear (Min)	20mm
Minimum Clearance to Combustible Materials	450mm

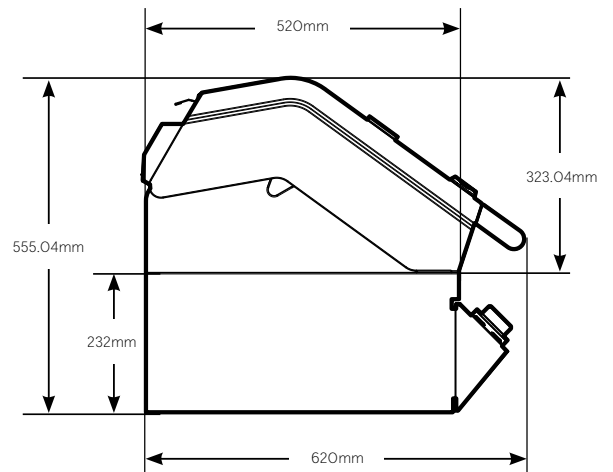
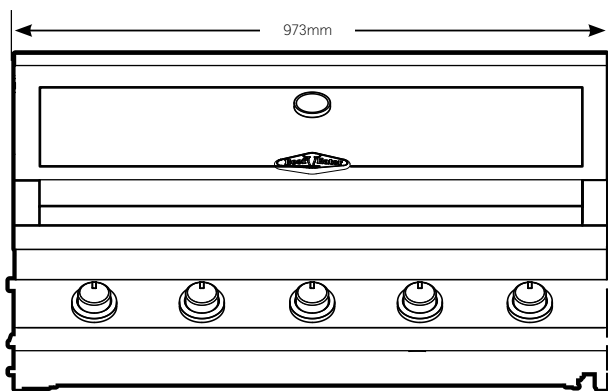
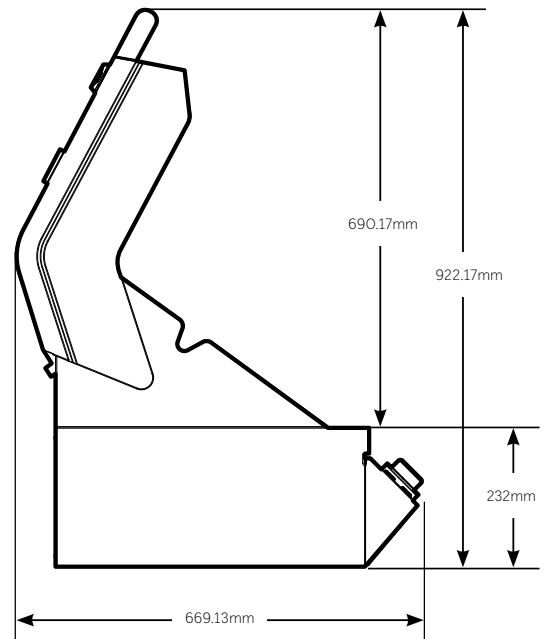
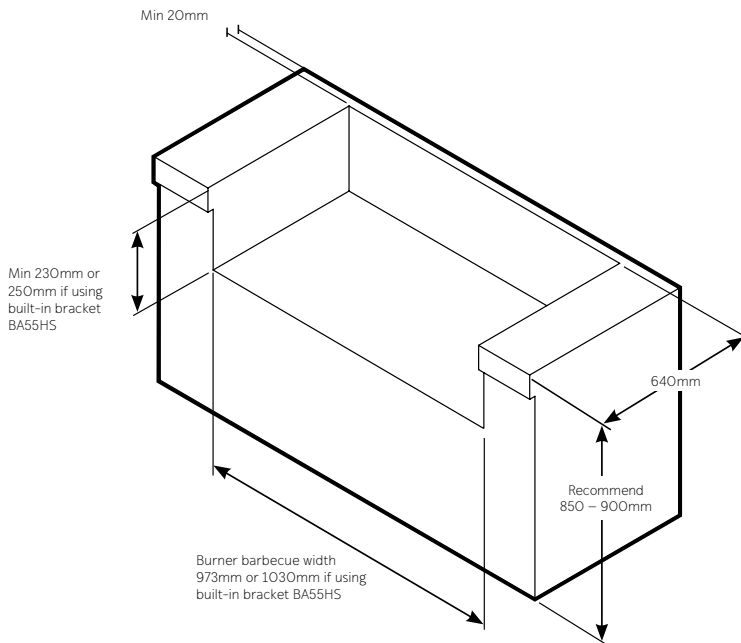

*All measurements are in mm

LIFE TASTES BETTER OUTDOORS